

A BI-DIRECTIONAL QUASI-OPTICAL LENS AMPLIFIER

Stein Hollung, James Vian and Zoya B. Popović

Department of Electrical and Computer Engineering
University of Colorado
Boulder, CO 80309

Abstract— A 10-element bi-directional quasi-optical lens amplifier array is presented. The amplifier is designed for X-band, and operates in transmission mode. SPDT switches are used to switch between transmit and receive amplifiers. An ON/OFF ratio of 25 dB is measured for both transmitting and receiving modes with associated amplifier gains of 5 and 10 dB.

I. INTRODUCTION

SEVERAL transmission-mode plane-wave fed quasi-optical amplifiers for microwave and millimeter-wave power combining have been presented to date [1,2,3]. Each of these amplifiers is fed with a plane wave from a source in the far field. In order to improve feed efficiency, lens amplifier arrays were developed [4,5]. In a transmission-mode lens amplifier, the feed is placed in the near field along the focal surface, thereby minimizing diffraction loss. A lens amplifier can also be used in reception offering high dynamic range. In this case, a plane wave is received and focused onto a mixer [6]. The lens amplifier array concept can be used for a T/R module, Fig. 1. Here we present a 10-element bi-directional quasi-optical amplifier with a unit cell as shown in Fig. 2.

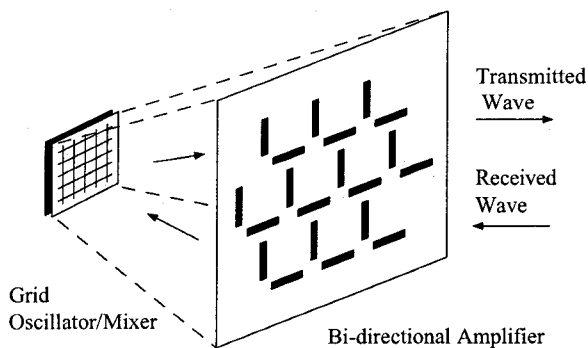

Fig. 1. A quasi-optical tranceive module consisting of a bi-directional amplifier and a grid oscillator/mixer.

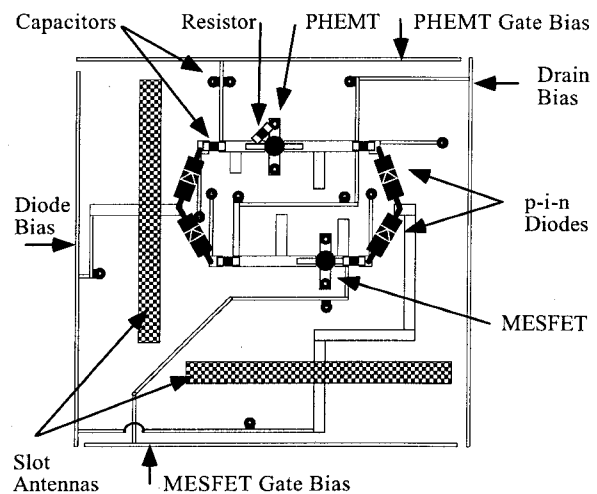

Fig. 2. A bi-directional quasi-optical array amplifier element. The slot antennas are 2.5 cm long and 2 mm wide, and the unit cell dimensions are 3.5 by 3.7 cm.

II. SINGLE ARRAY ELEMENT

The bi-directional transmission amplifier element is designed to operate around 10 GHz, and fabricated on a 0.507-mm-thick $\epsilon_r = 2.2$ Duroid substrate. A circuit schematic of the array element is shown in Fig. 3. Two SPDT switches are used to switch between a general-purpose MESFET amplifier stage for transmit mode and a PHEMT amplifier stage for receive mode. Both amplifiers are matched for gain in this unit cell. The receive amplifier is stabilized with a 200- Ω chip resistor from gate to source. Two p-i-n diodes are used for each switch. Orthogonally polarized antiresonant slot antennas are used at input and output because of their wide bandwidth and ease of fabrication with microstrip feed lines. Measured and simulated return loss for a slot antenna are shown in Fig. 4. Both the characteristic impedance of the microstrip and the antenna input impedance are 65 Ω , to avoid additional matching sections for the antennas. The DC bias for the diodes is

WE
3C

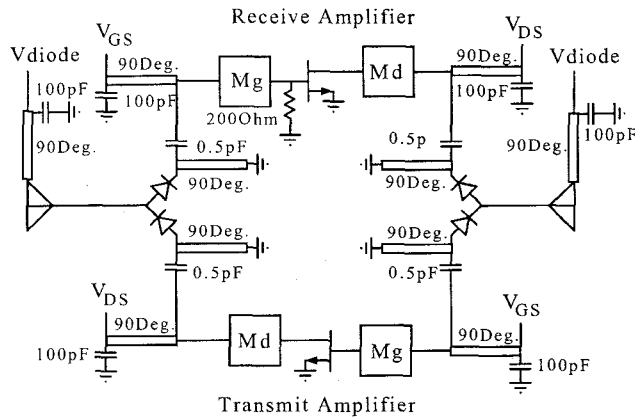

Fig. 3. Circuit schematic of the unit cell. Both amplifiers are matched for gain.

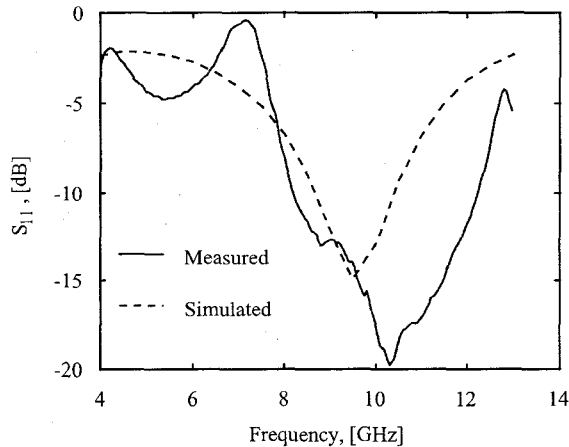

Fig. 4. Measured (—) and simulated (---) return loss of a single slot antenna. The simulations were performed with the CAD package *Ensemble*.

supplied through the slot antenna feed-lines. Both transistors share the same drain bias to reduce the number of bias lines.

Standard gain horns, connected to an HP 70820A Microwave Transition Analyzer and placed in the far field of the unit cell, are used for the measurements. In transmission, an incoming plane wave from a vertically polarized horn is amplified by the transmit amplifier, reradiated as a horizontally polarized plane wave and received by a horizontally polarized horn. In reception, an incoming plane wave from the horizontally polarized horn is amplified by the receive amplifier, reradiated as a vertically polarized plane wave and received by the vertically polarized horn. Polarizers are inserted at a half wavelength on each side of the unit cell to improve the gain. The received power is measured for both the

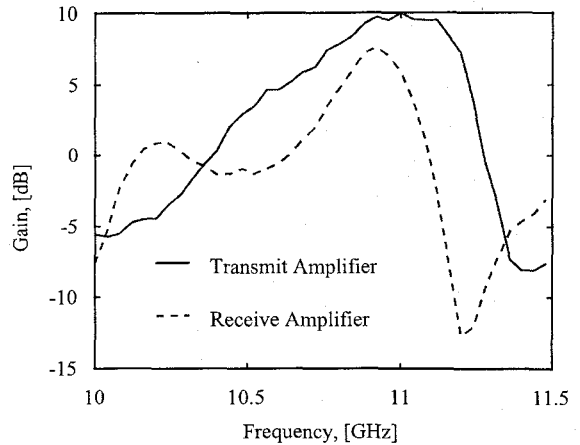

Fig. 5. Measured gain of the transmit (—) and receive (---) amplifier in a unit cell.

transmit and receive amplifiers over a range of frequencies. Measured ON/OFF ratios of about 10 and 20 dB are seen for the receive and transmit amplifiers, respectively. The gains of the amplifiers are calculated from the Friis formula and plotted in Fig. 5. A gain of 5.5 dB for the slot antennas with polarizers was used in the calculations. The transmit amplifier has a measured gain of 10 dB at 11 GHz. The receive amplifier has a measured gain of 7.5 dB at 10.8 GHz.

III. BI-DIRECTIONAL LENS AMPLIFIER ARRAY

The bi-directional lens amplifier array consists of 10 elements in a triangular lattice with three elements in the first and third row, and four elements in the second row as shown in Fig. 6. Lensing delay lines are incorporated between the antenna pairs in each unit cell. The delay line lengths were calculated using the design equations for a one degree of freedom lens [7]. The focal distance of the array is 27.5 cm. Each element in the array measures 3.5×3.7 cm. The gate bias lines are horizontal, while the drain and diode bias lines are distributed diagonally. An identical array with the amplifiers replaced by a through line is used for calibration of the measurements.

For reception, a horn antenna located in the far field of the array provides an incident horizontally polarized plane wave to the array. The array receives, amplifies and reradiates a vertically polarized wave to a receive horn located at the focal point. The received signal is measured using a transition analyzer. In transmission, the signal path is reversed. Two polarizers are inserted at a half wavelength on each side of the array to improve the gain. The passive array is also measured to provide a reference for the measurements. The measure-

ments are normalized to a through measurement with a 22×26 cm aperture and the transmit and receive horns co-polarized. A measured ON/OFF ratio of 25 dB for both receive and transmit mode are seen in Fig. 7. In receive mode, a maximum power gain of about 10 dB relative to the passive array is measured at 9.4 GHz. In transmit mode, the measured power gain is about 5 dB at 10.2 GHz. The lens amplifier has a measured beamwidth of about 20 degrees in both E and H-plane.

The lens amplifier can be cascaded with a 10.4 GHz grid oscillator/mixer to form a transceiver front end as shown in Fig. 1. A transmitted 10.1 GHz carrier AM modulated with a 10 kHz square wave are amplified and focused by the lens amplifier towards the self-oscillating mixer located at the focal point. The 290 MHz IF frequency present on the bias-lines of the oscillator is demodulated using an HP89441A Vector Signal Analyzer as shown in Fig. 9.

A simple measurement can be performed to show how a lens amplifier array can reduce the effect of multipath fading. A 45×30 cm metallic mirror located parallel to the optical axis in front of the array was translated in 3-mm steps from the axis. For each step, the mirror was rotated through a set of angles. The received power was measured for all mirror positions with and without the lens amplifier. The measured maximum fades of a 9.5 GHz carrier signal with and without the lens amplifier and normalized to the received signal without the mirror inserted are shown in Fig. 10. Fading nulls of less than -9 dB and more than -25 dB were measured with and without the lens amplifier, respectively. For some mirror positions, without the lens present, the fading nulls were as deep as -50 dB. This simple measurement show that a lens amplifier can provide a significant improvement of multipath fading effects in addition to improved dynamic range.

IV. CONCLUSION

A bi-directional quasi-optical lens amplifier array is presented. In transmit mode, the vertically polarized antiresonant slot antennas receive an input wave from a focal point and SPDT switches rout it through transmit amplifiers to the horizontally polarized output slots. In reception, the horizontally polarized slots couple the input signal through the receive amplifiers to the vertically polarized slots. Stable gains of 10 and 7.5 dB are measured for the transmit and receive amplifiers in each unit cell, respectively. An ON/OFF ratio of about 25 dB was measured for both transmit and receive mode of the array. The lens amplifier in reception demonstrates reduction of multipath fading.

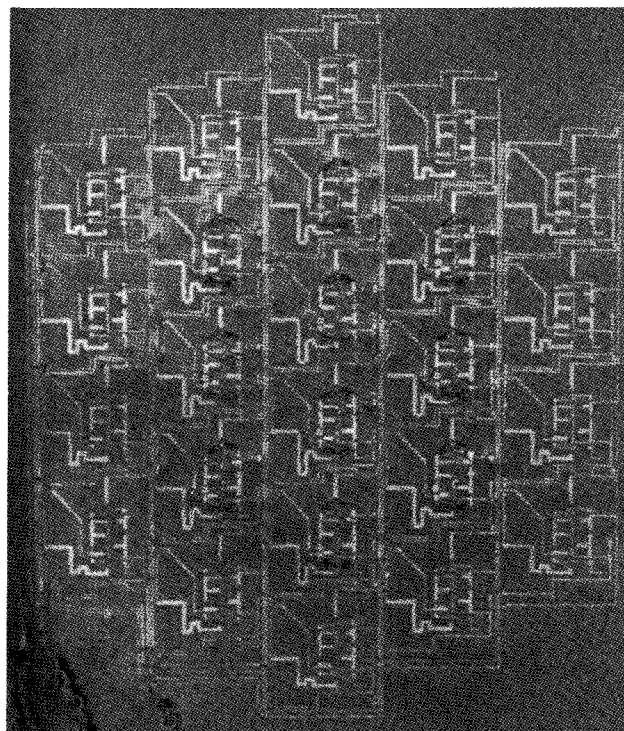

(a)

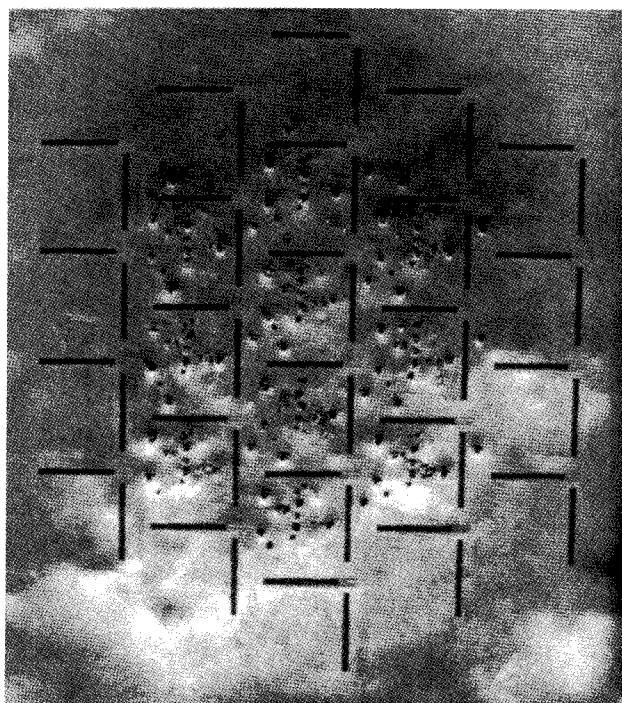

(b)

Fig. 6. Photograph of the bi-directional amplifier array. (a) Circuit side. (b) Antenna/ground plane.

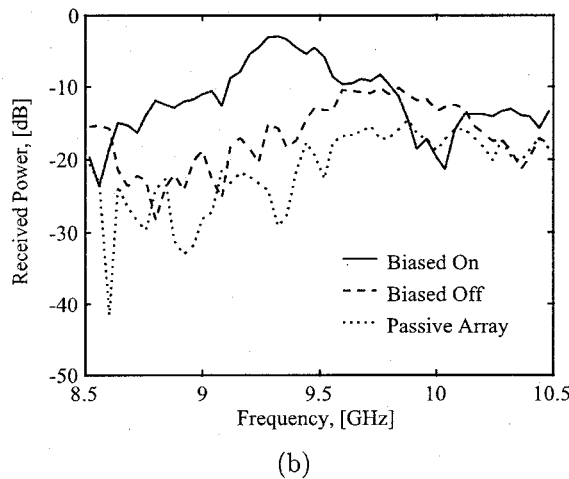
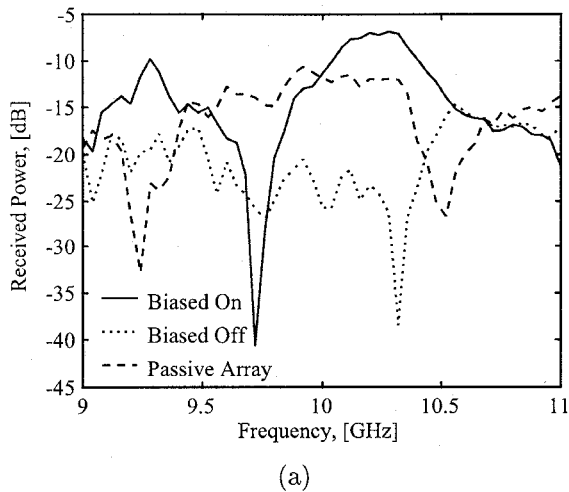

Fig. 7. (a) Measured ON/OFF ratio of the transmit amplifier array and a passive array with polarizers at input and output and calibrated with a through measurement. Transmit amplifier array biased on (-), biased off (-) and passive array (...). (b) Measured ON/OFF ratio of the receive amplifier array and a passive array with polarizers at input and output and calibrated with a through measurement. Receive amplifier array biased on (-), biased off (-) and passive array (...).

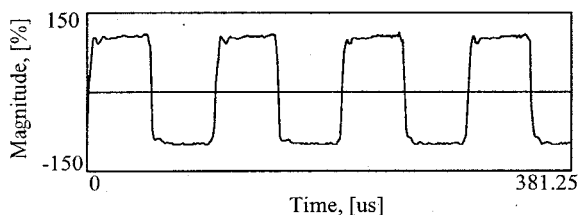

Fig. 8. AM demodulated 10 kHz squarewave signal received by a quasi-optical receiver front-end. The signal was AM modulated on a 10.1 GHz carrier, mixed to a 290 MHz IF frequency and demodulated using a vector signal analyzer.

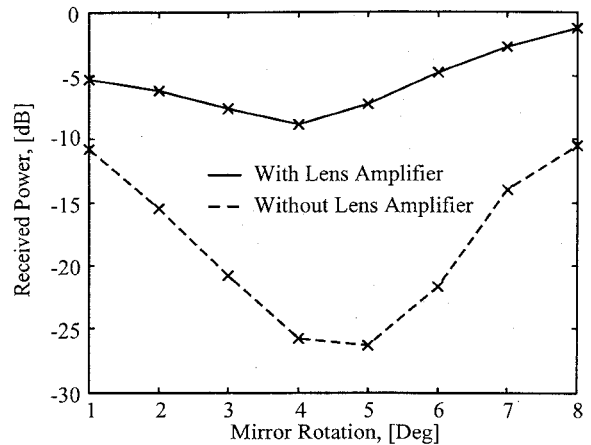

Fig. 9. An example of measured maximum multipath fading nulls of a 9.5 GHz carrier signal with and without a lens amplifier inserted. The received power is normalized to a through measurement without the mirror inserted.

V. ACKNOWLEDGMENT

This work was supported by the U.S. Army Research Office under grant #DAAH 04-56-1-0343. The authors wish to thank Rogers Corp. for substrate donations, and Boulder Microwave Technologies, Inc. for use of *Ensemble*.

REFERENCES

- [1] M. Kim, E. A. Sovero, J. B. Hacker, M. P. DeLisio, J. C. Chiao, S. J. Li, D. R. Gagnon, J. J. Rosenberg, and D. B. Rutledge, "A 100-element HBT grid amplifier," *IEEE Trans. Microwave Theory Tech.*, vol. MTT-41, no. 10, pp. 1762-1771, Oct. 1993.
- [2] H. S. Tsai, M. J. Rodwell, and R. A. York, "Planar amplifier array with improved bandwidth using folded-slots," *IEEE Microwave and Guided Wave Letters*, vol. 4, pp. 112-114, Apr. 1994.
- [3] Nilay Sheth, Toni Ivanov, Arul Balasubramanian, and Amir Mortazawi, "A nine HEMT spatial amplifier," *IEEE MTT-S Int. Microwave Symp. Dig.*, San Diego, CA, vol. 2, pp. 1239-1242, June 1994.
- [4] J. S. H. Schoenberg, S. C. Bundy, and Z. B. Popović, "Two-level power combining using a lens amplifier," *IEEE Trans. Microwave Theory Tech.*, vol. MTT-42, no. 12, pp. 2480-2485, Dec. 1994.
- [5] J. Schoenberg, T. Mader, B. Shaw, and Z. B. Popović, "Quasi-optical antenna array amplifiers," *IEEE MTT-S Int. Microwave Symp. Dig.*, Orlando, FL, vol. 2, pp. 605-608, June 1995.
- [6] W. Shiroma, E. Bryerton, S. Hollung, and Z. B. Popović, "A quasi-optical receiver with angle diversity," *IEEE MTT-S Int. Microwave Symp. Dig.*, San Francisco, CA, vol. 2, pp. 1131-1134, June 1996.
- [7] D. T. McGrath, "Planar three-dimensional constrained lenses," *IEEE Trans. Antennas and Prop.*, vol. AP-34, no. 1, pp. 46-50 Jan. 1986.