

DM74LS11 Triple 3-Input AND Gates

General Description

This device contains three independent gates each of which performs the logic AND function.

Features

- Alternate military/aerospace device (54LS11) is available. Contact a Fairchild Semiconductor Sales Office/Distributor for specifications.

Connection Diagram

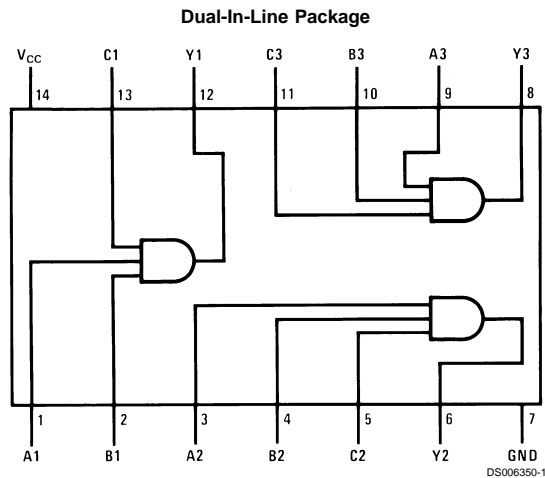

Order Number 54LS11DMQB, 54LS11FMQB, 54LS11LMQB,
DM54LS11J, DM54LS11W, DM74LS11M or DM74LS11N
See Package Number E20A, J14A, M14A, N14A or W14B

Function Table

$$Y = ABC$$

Inputs			Output
A	B	C	Y
X	X	L	L
X	L	X	L
L	X	X	L
H	H	H	H

H = High Logic Level
L = Low Logic Level
X = Either Low or High Logic Level

Absolute Maximum Ratings (Note 1)

Supply Voltage
 Input Voltage
 Operating Free Air Temperature Range

7V
 7V

DM54LS and 54LS
 DM74LS
 Storage Temperature Range

-55°C to +125°C
 0°C to +70°C
 -65°C to +150°C

Recommended Operating Conditions

Symbol	Parameter	DM54LS11			DM74LS11			Units
		Min	Nom	Max	Min	Nom	Max	
V _{CC}	Supply Voltage	4.5	5	5.5	4.75	5	5.25	V
V _{IH}	High Level Input Voltage	2			2			V
V _{IL}	Low Level Input Voltage			0.7			0.8	V
I _{OH}	High Level Output Current			-0.4			-0.4	mA
I _{OL}	Low Level Output Current			4			8	mA
T _A	Free Air Operating Temperature	-55		125	0		70	°C

Note 1: The "Absolute Maximum Ratings" are those values beyond which the safety of the device cannot be guaranteed. The device should not be operated at these limits. The parametric values defined in the "Electrical Characteristics" table are not guaranteed at the absolute maximum ratings. The "Recommended Operating Conditions" table will define the conditions for actual device operation.

Electrical Characteristics

over recommended operating free air temperature range (unless otherwise noted)

Symbol	Parameter	Conditions	Min	Typ (Note 2)	Max	Units
V _I	Input Clamp Voltage	V _{CC} = Min, I _I = -18 mA			-1.5	V
V _{OH}	High Level Output Voltage	V _{CC} = Min, I _{OH} = Max	DM54	2.5	3.4	V
		V _{IH} = Min	DM74	2.7	3.4	
V _{OL}	Low Level Output Voltage	V _{CC} = Min, I _{OL} = Max	DM54	0.25	0.4	V
		V _{IL} = Max	DM74	0.35	0.5	
		I _{OL} = 4 mA, V _{CC} = Min	DM74	0.25	0.4	
I _I	Input Current @ Max Input Voltage	V _{CC} = Max, V _I = 7V			0.1	mA
I _{IH}	High Level Input Current	V _{CC} = Max, V _I = 2.7V			20	µA
I _{IL}	Low Level Input Current	V _{CC} = Max, V _I = 0.4V			-0.36	mA
I _{OS}	Short Circuit Output Current	V _{CC} = Max	DM54	-20	-100	mA
		(Note 3)	DM74	-20	-100	
I _{CCH}	Supply Current with Outputs High	V _{CC} = Max		1.8	3.6	mA
I _{CCL}	Supply Current with Outputs Low	V _{CC} = Max		3.3	6.6	mA

Switching Characteristics

at $V_{CC} = 5V$ and $T_A = 25^\circ C$ (See for Test Waveforms and Output Load)

Symbol	Parameter	$R_L = 2\text{ k}\Omega$				Units
		$C_L = 15\text{ pF}$		$C_L = 50\text{ pF}$		
		Min	Max	Min	Max	
t_{PLH}	Propagation Delay Time Low to High Level Output	4	13	6	18	ns
t_{PHL}	Propagation Delay Time High to Low Level Output	3	11	5	18	ns

Note 2: All typicals are at $V_{CC} = 5V$, $T_A = 25^\circ C$.

Note 3: Not more than one output should be shorted at a time, and the duration should not exceed one second.

Physical Dimensions inches (millimeters) unless otherwise noted

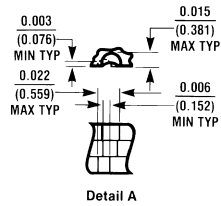
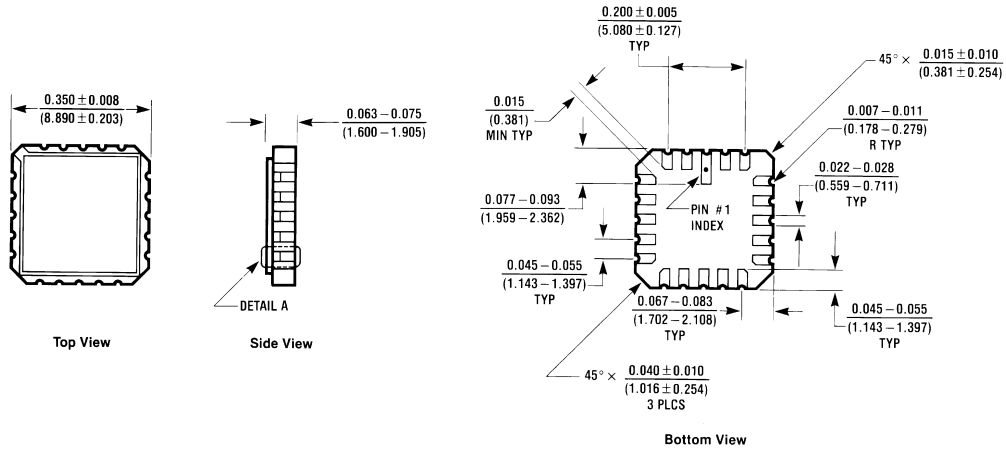

Ceramic Leadless Chip Carrier Package (E)
 Order Number 54LS11MQB
 Package Number E20A

E20A (REV D)

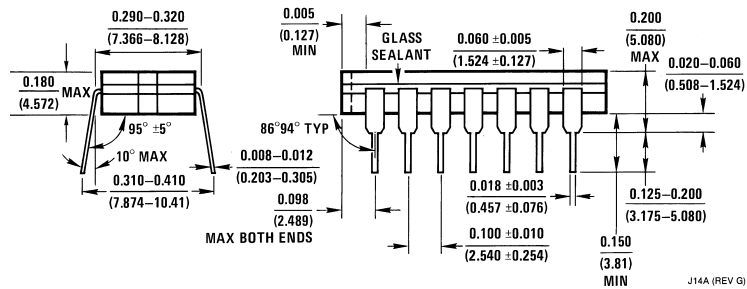
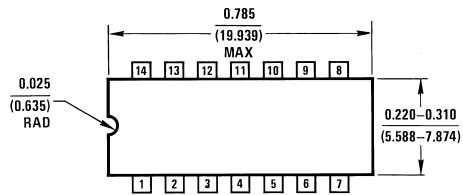

14-Lead Ceramic Dual-In-Line Package (J)
 Order Number 54LS11DMQB or DM54LS11J
 Package Number J14A

Physical Dimensions inches (millimeters) unless otherwise noted (Continued)

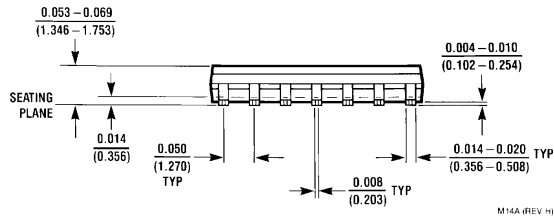
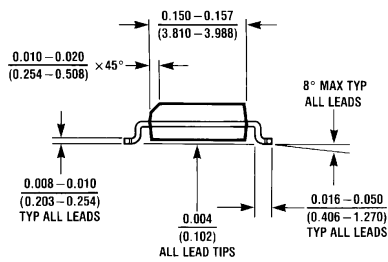
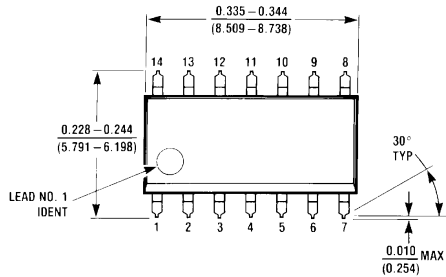

14-Lead Small Outline Molded Package (M)
Order Number DM74LS11M
Package Number M14A

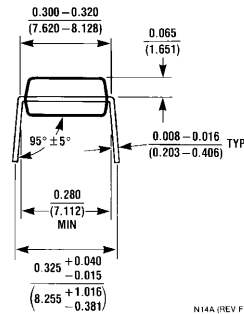
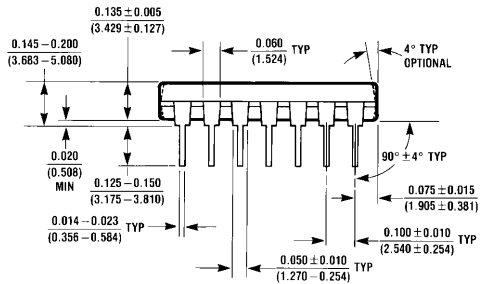
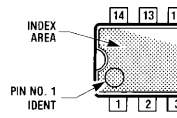
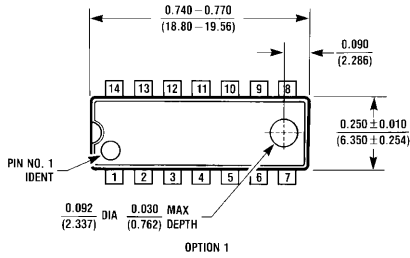

14-Lead Molded Dual-In-Line Package (N)
Order Number DM74LS11N
Package Number N14A

Physical Dimensions inches (millimeters) unless otherwise noted (Continued)

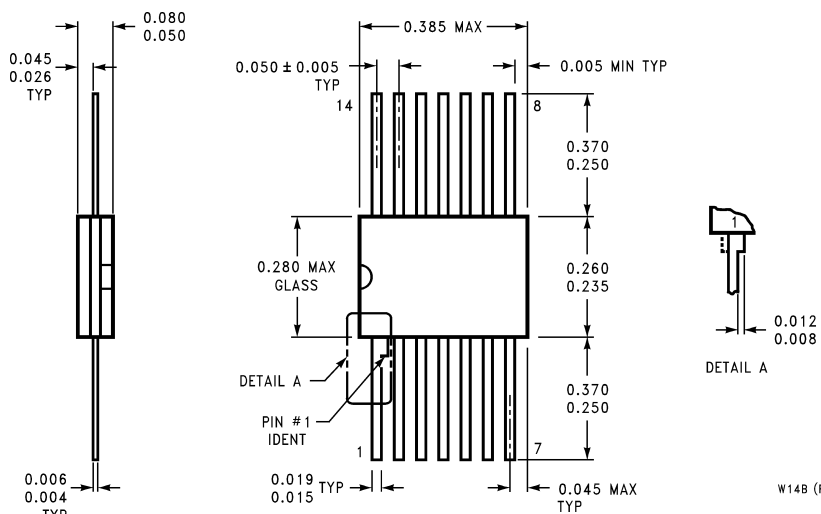

14-Lead Ceramic Flat Package (W)
Order Number 54LS11FMQB or DM54LS11W
Package Number W14B

W14B (REV J)

LIFE SUPPORT POLICY

FAIRCHILD'S PRODUCTS ARE NOT AUTHORIZED FOR USE AS CRITICAL COMPONENTS IN LIFE SUPPORT DEVICES OR SYSTEMS WITHOUT THE EXPRESS WRITTEN APPROVAL OF THE PRESIDENT OF FAIRCHILD SEMICONDUCTOR CORPORATION. As used herein:

1. Life support devices or systems are devices or systems which, (a) are intended for surgical implant into the body, or (b) support or sustain life, and (c) whose failure to perform when properly used in accordance with instructions for use provided in the labeling, can be reasonably expected to result in a significant injury to the user.
2. A critical component in any component of a life support device or system whose failure to perform can be reasonably expected to cause the failure of the life support device or system, or to affect its safety or effectiveness.

Fairchild Semiconductor Corporation Americas
 Customer Response Center
 Tel: 1-888-522-5372

Fairchild Semiconductor Europe
 Fax: +49 (0) 1 80-530 85 86
 Email: europe.support@nsc.com
 Deutsch Tel: +49 (0) 8 141-35-0
 English Tel: +44 (0) 1 793-85-68-56
 Italy Tel: +39 (0) 2 57 5631

Fairchild Semiconductor Hong Kong Ltd.
 13th Floor, Straight Block,
 Ocean Centre, 5 Canton Rd.
 Tsimshatsui, Kowloon
 Hong Kong
 Tel: +852 2737-7200
 Fax: +852 2314-0061

National Semiconductor Japan Ltd.
 Tel: 81-3-5620-6175
 Fax: 81-3-5620-6179

www.fairchildsemi.com